

**UNITED NATIONS / DOT
PERFORMANCE CERTIFICATION**



4G DESIGN QUALIFICATION

**4 x 9 Pint Beta Plastic Bottle with Standard
Closure Packaging and Two Case Sealing
Mechanisms**

TEST REPORT #: 15-CA20085A

Ⓢ 4G / X23.2 / S / **
USA / +CC7640

**Insert the year packaging is manufactured

Ⓢ 4G / Y33.8 / S / **
USA / +CC7640

**Insert the year packaging is manufactured

TESTING PERFORMED FOR:

PUREPAK TECHNOLOGY CORPORATION

324 South Bracken Lane Suite3
Chandler, AZ 85224

ATTN: Michael Dodd

TESTING PERFORMED BY:

TEN-E PACKAGING SERVICES, INC.

326 North Corona Avenue
Ontario, CA 91764
Phone: 909-937-1260
Fax: 909-937-1262

June 10, 2015

TABLE OF CONTENTS

SECTION I: CERTIFICATION 3
SECTIONS II & V: PACKAGING DESCRIPTIONS / COMPONENT DRAWINGS 4
 COMPONENT INFORMATION 5
SECTION III: TEST PROCEDURES AND RESULTS 8
 DROP TESTS Taped Top & Bottom Flaps 8
 DROP TESTS Taped Top & Glued Flaps 9
 STACKING & STACKING STABILITY TESTS Taped Top & Bottom Flaps 10
 STACKING & STACKING STABILITY TESTS Taped Top & Glued Flaps 11
 PRESSURE DIFFERENTIAL TEST 12
 VIBRATION TEST Taped Top & Bottom Flaps 13
 VIBRATION TEST Taped Top & Glued Flaps 14
 COBB WATER ABSORPTION TEST 15
REGULATORY AND INDUSTRY STANDARD REFERENCES 16
SECTION IV: MATHEMATICAL CALCULATIONS P.G. I 17
SECTION IV: MATHEMATICAL CALCULATIONS P.G. II 19

NOTES AND COMMENTS

- Tested as a design qualification due to a change in the corrugated basis weight. The packaging will retain the +CC7640 Identification.
- Testing was conducted to meet (Packing Group I / 1.3 SG & Packing Group II / 1.95 SG)

4 x 9 Pint Beta Plastic Bottle Packaging – Case Sealing Mechanism Variables

Option #	Top Flaps	Bottom Flaps
1	2" 3M Scotch Brand Tape	2" 3M Scotch Brand Tape
2	2" 3M Scotch Brand Tape	Hot Melt Adhesive

SECTION I: CERTIFICATION

**Design Qualification of the PurePak Technology Corporation
 4 x 9 Pint Beta Plastic Bottle with Standard Closure Packaging and Two Case Sealing
 Mechanisms**

TEN-E Packaging Services, Inc. is a current DOT UN Third-Party Certification Agency under §107.403 and certifies that the PurePak Technology Corporation packaging referenced above has passed the standards of the DEPARTMENT OF TRANSPORTATION'S TITLE 49 CFR; Performance Oriented Packaging Standards, Section 178. This package is also certified under IMDG, ICAO/IATA Regulations and the UN Recommendations on the Transport of Dangerous Goods. It is the responsibility of the end user to determine authorization for use under these regulations. The use of other packaging methods or components other than those documented in this report may render this certification invalid.

SUMMARY OF PERFORMANCE TESTS

UN / DOT TEST	CFR REFERENCE	TEST LEVEL	TEST CONTENTS	TEST COMPLETED	TEST RESULTS				
Drop	178.603	2.0 m	Methanol/Water	June 4, 2015	PASS				
Stacking	178.606	771.1 Kg – 24 Hours	Water	June 10, 2015	PASS				
Pressure	173.27	100 kPa - 30 Minutes	Water	June 9, 2015	PASS				
Vibration	178.608	4.0 Hz – 1 Hour	Water	June 8, 2015	PASS				
Cobb	178.516	30 Minutes	---	June 3, 2015	PASS				
TEST REPORT NUMBER:			15-CA20085A						
UN MARKING: (CFR 49 – 178.503)			<table border="0"> <tr> <td align="center">(u n)</td> <td>4G / X23.2 / S / ** USA / +CC7640</td> </tr> <tr> <td align="center">(u n)</td> <td>4G / Y33.8 / S / ** USA / +CC7640</td> </tr> </table>			(u n)	4G / X23.2 / S / ** USA / +CC7640	(u n)	4G / Y33.8 / S / ** USA / +CC7640
(u n)	4G / X23.2 / S / ** USA / +CC7640								
(u n)	4G / Y33.8 / S / ** USA / +CC7640								
PACKAGING IDENTIFICATION CODE:			4G - Fiberboard Box (178.516)						
PERFORMANCE STANDARD:			X (Packaging meets Packing Group I, II and III tests)						
AUTHORIZED GROSS MASS:			Y (Packaging meets Packing Group II and III tests)						
"S" DESIGNATION:			PG I: 23.2 Kg (51.1 Lbs) (Based on 1.3 Specific Gravity) PG II: 33.8 Kg (74.5 Lbs) (Based on 1.95 Specific Gravity)						
YEAR OF MANUFACTURE:			Denotes Inner Packagings						
STATE AUTHORIZING THE MARK			** Insert year the packaging is manufactured						
PACKAGING CERTIFICATION AGENCY:			USA						
THIRD PARTY PACKAGING IDENTIFICATION:			(+CC) TEN-E Packaging Services, Inc. (Ontario CA #2006030021)						
PERIODIC RETEST DATE:			+CC7640						
			June 10, 2017						

ALL OTHER WARRANTIES, EXPRESSED OR IMPLIED, INCLUDING ANY WARRANTY THAT THE PACKAGING TESTED IS MERCHANTABLE OR FIT FOR A PARTICULAR PURPOSE, ARE DISCLAIMED. In no event shall TEN-E Packaging Services, Inc. liability exceed the total amount paid by PurePak Technology Corporation for services rendered. In the event of future changes to the above referenced test standards, it is the responsibility of PurePak Technology Corporation to determine whether additional testing or updating of past testing is necessary to verify that the packaging we have tested remains in compliance with those standards.

MANUFACTURER:
 PurePak Technology Corporation
 324 South Bracken Lane
 Suite 3
 Chandler, AZ 85224

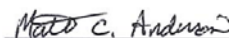
 Matt C. Anderson
 Project Manager
 TEN-E Packaging Services, Inc.

SECTIONS II & V: PACKAGING DESCRIPTIONS / COMPONENT DRAWINGS

4 x 9 Pint Beta Plastic Bottle Packaging with Two Case Sealing Mechanisms

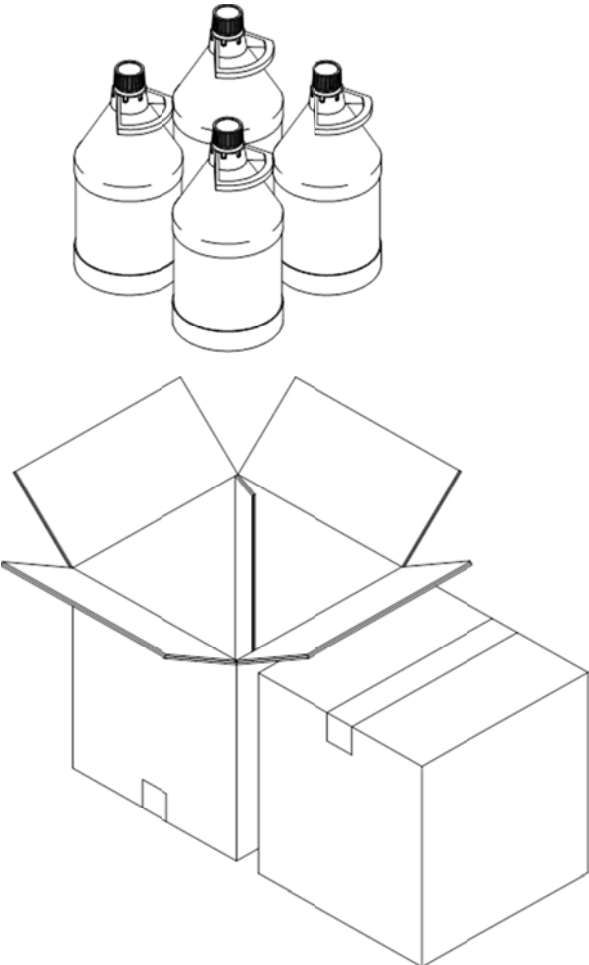
ASSEMBLY DRAWING	TEST LEVELS		
	Certification Type:	Design Qualification	
	Packaging Code Designation:	4G	
	Packing Group:	I & II	
	Specific Gravity:	PG I - 1.3 PG II - 1.95	
	Internal Pressure:	100 kPa	
	TEST SAMPLE PREPARATION (Refer to Section IV)		
	Overall Packaging Tare Weight:	1,735.0 Grams	
	Fill Capacity (98% Maximum Capacity):		
	Methanol/Water	4,010.5 Grams	
	Water	4,147.4 Grams	
	Package Test Weight:		
	Methanol/Water	17.7 Kg	39.0 Lbs
	Water	18.3 Kg	40.3 Lbs
	Authorized Package Gross	PG I: 23.3 Kg	51.3 Lbs
	Mass:	PG II: 34.0 Kg	74.9 Lbs
	CLOSING METHODS – INNER PACKAGING		
	Application Torque:	50 In-Lbs	
	Equipment:	Kaps All Electronic Torque Tester	
	CLOSING METHODS – SHIPPER		
	Top Flaps:		
Manufacturer:	3M: St. Paul, MN		
Type:	Options #1 & #2: 3M Scotch Brand Pressure Sensitive Tape supplied by client		
Width:	48 mm (2")		
Overlap:	2" Minimum		
Tape Pattern:	Center Seam		
Inner Flaps:	Meet		
Outer Flaps:	Meet		
Bottom Flaps:			
Manufacturer:	3M: St. Paul, MN		
Type:	Option #1) 3M Scotch Brand Pressure Sensitive Tape supplied by client Option #2) Hot Melt Adhesive (Prepared by Client as for Transport) (Three Strips of Thermoset Adhesive – 4/8" x 4")		
Width:	48 mm (2")		
Overlap:	2" Minimum		
Tape Pattern:	Center Seam		
Inner Flaps:	Meet		
Outer Flaps:	Meet		

For Packagings with an Established Gross Mass:

If the gross mass calculation in this report exceeds the previously established gross mass, the manufacturer may elect to maintain the current gross mass marking (e.g. the gross mass rating of the UN marking on the packaging may be less than the calculated gross mass indicated in this report) or use the newly established gross mass. In no event shall the gross mass marking on the packaging exceed the gross mass to which the packaging was tested.

COMPONENT INFORMATION

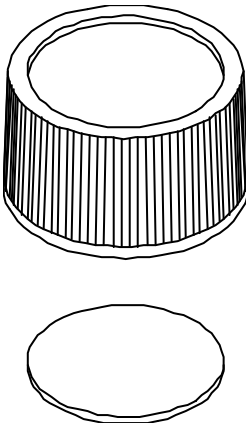
CLOSURE		DRAWING
Manufacturer: Rexam Plastic Packaging: Evansville, IN (QIM-317-4937)		
Description:	38mm Threaded Closure	
Quantity:	4	
Material:	Polypropylene	
Tare Weight:	10.30 Grams	
Overall Dimensions:		
• Height	1.016" ± 0.015"	
• Diameter	1.701" ± 0.015"	
Thread:		
• Type	38	
• Style	439	
Finish Dimensions:		
• T	1.483" ± 0.007"	
• E	1.389" ± 0.007"	
Markings (QC Audit):	24	
Liner		
• Description	Foam Liner	
• Tare Weight	0.64 Grams	
• Thickness	0.051"	
• Diameter	1.390"	

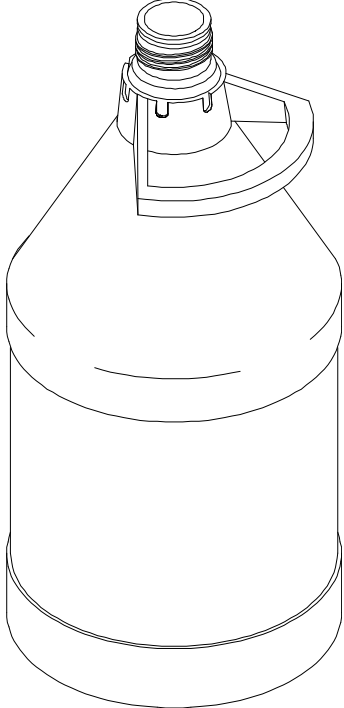
PLASTIC BOTTLE		DRAWING
Manufacturer: PurePak Technology Corporation: Chandler, AZ		
Description:	9 Pint Beta Plastic Bottle with Oval Handle	
Quantity:	4	
Material/Pigment:	High Density Polyethylene – Equistar LR 7340 / Natural	
Method of Manufacture:	Blow Molded	
Tare Weight:	190 Grams ± 5 Grams	
Capacity:		
• Rated	9 Pint	
• Overflow	4,194.0 Grams (1.1 Gallons)	
Overall Dimensions:		
• Height	12.694" ± 0.045"	
• Diameter	6.231" ± 0.117"	
Thread Dimensions:		
• T	1.461" ± 0.041"	
• E	1.367" ± 0.056"	
Wall Thickness:		
• Minimum	0.030"	
Markings (QC Audit):	SPI "2" HDPE Recycling Symbol PPT 4/15 1 M4851 / 4600	

SHIPPER		
Manufacturer: PCA: Phoenix, AZ (Projects – 507089, 507097 & 507098)		
Description:	Regular Slotted Container	
Material/Flute (Inner to Outer):	51 ECT Double Wall Mottled White Corrugated Fiberboard; C/B-Flute	
Basis Weight (Outer to Inner) Lbs./MSF:		
• Specification	42MW-23M-35-23M-35	
Tare Weight:	811 Grams	
DIMENSIONS		
	Specification Dimensions (Inside)	Measured Dimensions (Outside)
• Length	12-3/4"	13-3/8"
• Width	12-3/4"	13-1/4"
• Height	13"	14-1/4"
Board Caliper (Nominal):	0.265"	
Manufacturer's Joint:	Inside Glued, 1-1/2" Lap	
No Box Manufacturer's Certification:		
Markings (QC Audit):	NONE	







SECTION III: TEST PROCEDURES AND RESULTS

DROP TESTS

Taped Top & Bottom Flaps

TEST INFORMATION		TEST CRITERIA
TEST CONTENTS:	Methanol/Water Solution (0.967 SG)	<ul style="list-style-type: none"> For packaging containing liquid, each packaging does not leak. There can be no damage to the outer packaging likely to adversely affect safety during transport. Inner receptacles, inner packagings or articles must remain completely within the outer packaging and there must be no leakage of the filling substance from the inner packaging. Any discharge from a closure is slight and ceases immediately after impact with no further leakage. No rupture is permitted in packagings for materials in Class 1 which would permit spillage of loose explosive substances or articles from the outer packaging. (\$178.603)
SAMPLE PREPARATION:	Refer to Section II	
CONDITIONING:	-18°C (0°F) Freezer #201	
CONTENTS TEMP.:	-18.1°C (-0.6°F)	
DROP HEIGHT:	2.0 Meters (79") (Refer to Section IV)	
TEST EQUIPMENT:	L.A.B. Accu Drop 160	

DROP ORIENTATIONS AND TEST RESULTS

Sample #1: Flat on Bottom	Sample #2: Flat on Top	*Sample #3: Flat on Long Side
		
PASS: No leakage or damage.	PASS: No leakage or damage.	PASS: No leakage or damage.
*Sample #4: Flat on Short Side	*Sample #5: Bottom Corner	**Sample #1: Top Corner
		
PASS: No leakage or damage.	PASS: No leakage. Deformation to shipper on impact.	PASS: No leakage. Deformation to shipper on impact.

*Side and corner drops were conducted to impact the manufacturer's joint







** Flat on Bottom Drop sample was also used for the Top Corner drop.

DROP TESTS
Flaps

Taped Top & Glued Bottom

TEST INFORMATION		TEST CRITERIA
TEST CONTENTS:	Methanol/Water Solution (0.967 SG)	<ul style="list-style-type: none"> For packaging containing liquid, each packaging does not leak. There can be no damage to the outer packaging likely to adversely affect safety during transport. Inner receptacles, inner packagings or articles must remain completely within the outer packaging and there must be no leakage of the filling substance from the inner packaging. Any discharge from a closure is slight and ceases immediately after impact with no further leakage. No rupture is permitted in packagings for materials in Class 1 which would permit spillage of loose explosive substances or articles from the outer packaging. (\$178.603)
SAMPLE PREPARATION:	Refer to Section II	
CONDITIONING:	-18°C (0°F) Freezer #201	
CONTENTS TEMP.:	-18.1°C (-0.6°F)	
DROP HEIGHT:	2.0 Meters (79") (Refer to Section IV)	
TEST EQUIPMENT:	L.A.B. Accu Drop 160	

DROP ORIENTATIONS AND TEST RESULTS

Sample #12: Flat on Bottom	Sample #13: Flat on Top	*Sample #14: Flat on Long Side
		
PASS: No leakage or damage.	PASS: No leakage or damage.	PASS: No leakage or damage.
*Sample #15: Flat on Short Side	*Sample #16: Bottom Corner	**Sample #12: Top Corner
		
PASS: No leakage or damage.	PASS: No leakage. Deformation to shipper on impact.	PASS: No leakage. Deformation to shipper on impact.

*Side and corner drops were conducted to impact the manufacturer's joint

** Flat on Bottom Drop sample was also used for the Top Corner drop.

STACKING & STACKING STABILITY TESTS

Taped Top & Bottom Flaps

TEST INFORMATION		TEST CRITERIA
TEST CONTENTS:	Water	<ul style="list-style-type: none"> • There must be no leakage of the filling substance from the inner receptacle, or inner packaging. • There can be no deterioration that could adversely affect transport safety or any distortion liable to reduce the package's strength, cause instability in stacks of packages, or cause damage to inner packagings that is likely to reduce safety in transport. <p>(§178.606)</p>
SAMPLE PREPARATION:	Refer to Section II	
CONDITIONING:	73°F / 50% RH Quality Room #202	
TEST LOAD APPLIED:	771.1 Kg (1,700.0 Lbs) (Refer to Section IV)	
TEST DURATION:	24 Hours	
TEST EQUIPMENT:	L.A.B. 5250 Compression System	

STACKING TEST SET-UP & RESULTS

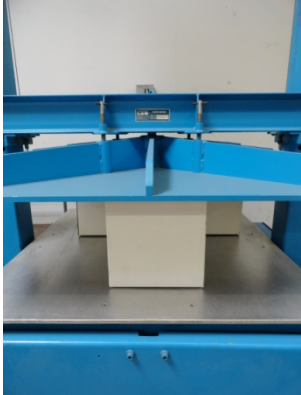
	Sample #	Maximum Deflection After 24 Hours	Results
	6	0.120"	PASS
	7	0.120"	PASS
	8	0.120"	PASS
Comments/Observations			
Following the stack test there was no leakage or damage likely to result in failure of the packaging.			

STACKING STABILITY TEST SET-UP & RESULTS

	Results	CRITERIA FOR PASSING THE TEST
	PASS	<ul style="list-style-type: none"> • In guided load tests, stacking stability must be assessed after test completion. • Two filled packagings of the same type must be placed on the test sample. • The stacked packages must maintain their position for one hour. <p>(§178.606)</p>
For stack stability, TEN-E places the filled samples one on top of the other. The bottom sample is rotated to the top until all three samples have been subjected to stacking stability for one hour each.		

STACKING & STACKING STABILITY TESTS
Flaps

Taped Top & Glued Bottom

TEST INFORMATION		TEST CRITERIA
TEST CONTENTS:	Water	<ul style="list-style-type: none"> There must be no leakage of the filling substance from the inner receptacle, or inner packaging. There can be no deterioration that could adversely affect transport safety or any distortion liable to reduce the package's strength, cause instability in stacks of packages, or cause damage to inner packagings that is likely to reduce safety in transport. (§178.606)
SAMPLE PREPARATION:	Refer to Section II	
CONDITIONING:	73°F / 50% RH Quality Room #202	
TEST LOAD APPLIED:	771.1 Kg (1,700.0 Lbs) (Refer to Section IV)	
TEST DURATION:	24 Hours	
TEST EQUIPMENT:	L.A.B. Validator Plus Compression System	

STACKING TEST SET-UP & RESULTS			
	Sample #	Maximum Deflection After 24 Hours	Results
	17	0.112"	PASS
	18	0.112"	PASS
	19	0.112"	PASS
	Comments/Observations		
<p>Following the stack test there was no leakage or damage likely to result in failure of the packaging.</p>			

STACKING STABILITY TEST SET-UP & RESULTS		
	Results	CRITERIA FOR PASSING THE TEST
	PASS	<ul style="list-style-type: none"> In guided load tests, stacking stability must be assessed after test completion. Two filled packagings of the same type must be placed on the test sample. The stacked packages must maintain their position for one hour. (§178.606)
<p>For stack stability, TEN-E places the filled samples one on top of the other. The bottom sample is rotated to the top until all three samples have been subjected to stacking stability for one hour each.</p>		

PRESSURE DIFFERENTIAL TEST

TEST INFORMATION		TEST CRITERIA
TEST CONTENTS:	Water	<ul style="list-style-type: none"> • Packaging for which retention of liquid is a basic function must be capable of withstanding the pressure requirements without leakage. (§173.27(c))
FILL CAPACITY:	Maximum Capacity	
CLOSURE APPLICATION:	Refer to Section II	
CONDITIONING:	Ambient	
TEST PRESSURE:	100 kPa	
TEST DURATION:	30 Minutes	
AREA OF PRESSURIZATION:	Through the Bottom	
TEST EQUIPMENT:	Regulated Water Source Digital Pressure Gauge	

HYDROSTATIC PRESSURE TEST SET-UP AND RESULTS

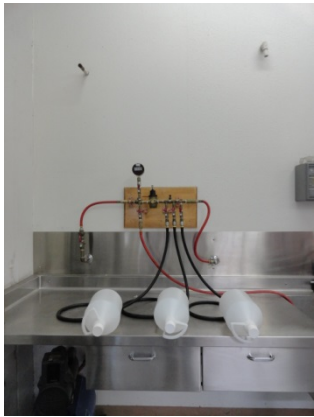
	Sample #	Results	Comments/Observations
	1	PASS	All three samples maintained the 100 kPa test pressure for 30 minutes without leakage or damage.
	2	PASS	
	3	PASS	

VIBRATION TEST

Taped Top & Bottom Flaps

TEST INFORMATION		TEST CRITERIA
TEST CONTENTS:	Water	<ul style="list-style-type: none"> Immediately following the period of vibration, each package must be removed from the platform, turned on its side and observed for any evidence of leakage. A packaging passes the vibration test if there is no rupture or leakage from any of the packages. No test sample should show any deterioration which could adversely affect transportation safety or any distortion liable to reduce packaging strength. <p>(§178.608)</p>
SAMPLE PREPARATION:	Refer to Section II	
CONDITIONING:	73°F / 50% RH Quality Room #202	
TABLE DISPLACEMENT:	1"	
TEST FREQUENCY:	4.0 Hz	
TEST DURATION:	1 Hour	
TEST EQUIPMENT:	Vertical motion using L.A.B. Palletizer Vibration System	

VIBRATION TEST SET-UP AND RESULTS

	Sample #	Results	Comments/Observations
	9	PASS	No leakage or damage.
	10	PASS	
	11	PASS	

**VIBRATION TEST
Flaps**

Taped Top & Glued Bottom

TEST INFORMATION		TEST CRITERIA
TEST CONTENTS:	Water	<ul style="list-style-type: none"> Immediately following the period of vibration, each package must be removed from the platform, turned on its side and observed for any evidence of leakage. A packaging passes the vibration test if there is no rupture or leakage from any of the packages. No test sample should show any deterioration which could adversely affect transportation safety or any distortion liable to reduce packaging strength. <p>(§178.608)</p>
SAMPLE PREPARATION:	Refer to Section II	
CONDITIONING:	73°F / 50% RH Quality Room #202	
TABLE DISPLACEMENT:	1"	
TEST FREQUENCY:	4.0 Hz	
TEST DURATION:	1 Hour	
TEST EQUIPMENT:	Vertical motion using L.A.B. Palletizer Vibration System	

VIBRATION TEST SET-UP AND RESULTS

	Sample #	Results	Comments/Observations
	9	PASS	No leakage or damage.
	10	PASS	
	11	PASS	

COBB WATER ABSORPTION TEST

TEST INFORMATION	TEST CRITERIA
<p>NUMBER OF SAMPLES: 5</p> <p>SAMPLE SIZE: 5" x 5" (Minimum)</p> <p>CONDITIONING: 73°F / 50% RH Quality Room #202</p> <p>WATER APPLIED: 100 mL / Sample</p> <p>TEST DURATION: 30 Minutes / Sample</p> <p>TEST EQUIPMENT: UWE Analytical Balance Gurley Cobb Water Absorption Fixtures</p>	<ul style="list-style-type: none"> An increase in mass greater than 155 g/m² over the 30 minute duration represents an unacceptable level of water resistance. (§178.516)

COBB WATER ABSORPTION TEST RESULTS	
Sample #	Water Absorbed
1	143 g/m ²
2	146 g/m ²
3	131 g/m ²
4	147 g/m ²
5	126 g/m ²
AVERAGE:	138.6 g/m²
RESULT	PASS

REGULATORY AND INDUSTRY STANDARD REFERENCES

REGULATORY REFERENCES

TEST	49 CFR ^①	UN ^②	IMDG ^③	ICAO ^④	IATA ^⑤
	October 2014 Edition	18 th Edition	2014 Edition	2015-2016 Edition	56th Edition
Drop:	178.603	6.1.5.3	6.1.5.3	6; 4.3	6.3.3
Stacking:	178.606	6.1.5.6	6.1.5.6	6; 4.6	6.3.6
Pressure:	173.27(c)	4.1.1.4.1	4.1.1.4.1	4; 1.1.6	5.0.2.9
Vibration:	178.608	---	---	4; 1.1.1	5.0.2.7
Cobb:	178.516(b)(1)	6.1.4.12.1	6.1.4.12.1	6; 3.1.11.1	6.2.12.2

- ① United States Department of Transportation Code of Federal Regulations (CFR) Title 49, Transportation, Parts 100-185
 ② The United Nations Recommendations on the Transport of Dangerous Goods – Model Regulations (UN – Orange Book)
 ③ International Maritime Dangerous Goods Code (IMDG)
 ④ Technical Instructions for the Safe Transport of Dangerous Good by Air (ICAO)
 ⑤ International Air Transport Association (IATA) Dangerous Goods Regulations

INDUSTRY STANDARD REFERENCES

Drop:	ASTM ^⑥ D5276:	Standard Test Method for Drop Test of Loaded Containers by Free Fall
	ASTM ^④ D7790	Standard Test Method for the Preparation of Plastic Packagings Containing Liquids for United Nations (UN) Drop Testing
	ISO ^⑦ 2248:	Packaging – Complete, Filled Transport Packages – Vertical Impact Test by Dropping
Stacking:	ASTM ^⑥ D4577:	Standard Test Method for Compression Resistance of a Container Under Constant Load
	ISO ^⑦ 2234:	Packaging – Complete, Filled Transport Packages – Stacking Test using Static Load
Hydrostatic Pressure:	ASTM ^⑥ D7660:	Standard Guide for Conducting Internal Pressure Tests on United Nations (UN) Packagings
Vibration:	ASTM ^⑥ D999:	Standard Test Method for Vibration Testing of Shipping Containers
	ISO ^⑦ 2247:	Packaging – Complete, Filled Transport Packages – Vibration Test at Fixed Low Frequency
Cobb:	ISO ^⑦ 535:	Paper and Board – Determination of Water Absorption – Cobb Method

- ⑥ American Society for Testing and Materials (ASTM)
 ⑦ International Organization for Standardization (ISO)

EQUIPMENT

All inspection, measuring and test equipment that can affect product quality is calibrated and adjusted at prescribed intervals, or prior to use, and is traceable to NIST, using ANSI Z540 as an overall guide for calibration certification.

SECTION IV: MATHEMATICAL CALCULATIONS

P.G. I

INFORMATION USED FOR CALCULATIONS

Overall Packaging Tare Weight (PTW):	1,735.0 Grams	
Overflow Capacity (OFC):		Methanol/Water SG
Methanol/Water	4,092.3 Grams	SG: 0.967
Water	4,232.0 Grams	
Number of Inner Packagings (# IP):	4	
Packing Group	1	
Product Specific Gravity (PSG):	1.300	
Packing Group Multiplication Factor (MF):	1.50	
Overall Height of one Package (OH):	14.25 Inches	
Stack Test-# of Samples Tested Simultaneously:	3	

98% OF OVERFLOW

Overflow Capacity (OFC) x 98%

<u>OFC</u>	x	<u>98%</u>		
4,092.3	x	98% =	4,010.5 Grams	Methanol/Water
4,232.0	x	98% =	4,147.4 Grams	Water

PACKAGE TEST WEIGHTS

Overall Pkg Tare Weight (PTW) + (98% Overflow Capacity (OFC) x # of Inner Pkg (# IP))

<u>PTW</u>	+	<u>(98% OFC)</u>	x	<u># IP)</u>	
1,735	+	4,010.5	x	4	Methanol/Water
1,735	+	4,147.4	x	4	Water
Methanol/Water:		17.7	Kg	39.0	Lbs.
Water:		18.3	Kg	40.3	Lbs.

AUTHORIZED PACKAGE GROSS MASS CALCULATION (APGM)

Overall Pkg Tare Weight (PTW) + (Product SG (PSG) x 98% Overflow (OFC) x # of Inner Pkg (# IP))

<u>PTW</u>	+	<u>(PSG)</u>	x	<u>98% OFC</u>	x	<u># IP)</u>
1,735	+	1.3	x	4,147	x	4
		23.3	Kg	51.3	Lbs.	

DROP HEIGHT

Calculation For Product Specific Gravities Exceeding 1.2
Product Specific Gravity (PSG) x Packing Group Multiplication Factor (MF)

<u>PSG</u>	x	<u>MF</u>		Packing Group: I
1.3	x	1.50		
		1.95	Meter	
			<u>Required Drop Height</u>	<u>Actual Drop Height</u>
			76.8 Inches	77 Inches

STACKING TEST MINIMUM LOAD CALCULATIONS

Number of Packages in a 3m High Stack (118 / Overall Pkg Height (OH) -1)

118 / Overall Height of one Pkg (OH) - 1

<u>(118)</u>	/	<u>OH)</u>	-1	=	<u># 3m HS</u>
118	/	14.25	-1	=	7.3

Stacking Test Load Calculation (Individual Package)

Authorized Pkg Gross Mass (APGM) x # of Pkg in a 3m High Stack (# 3m HS)

<u>APGM</u>	x	<u># 3m HS</u>	
23.3	x	7.3	
			170.1 Kg 375.0 Lbs.

Stacking Test Load Calculation

Samples x Authorized Pkg Gross Mass (APGM) x # of Pkg in a 3m High Stack (# 3m HS)

<u>Samples</u>	x	<u>(APGM</u>	x	<u># 3m HS)</u>
3	x	23.3	x	7.3
				510.3 Kg 1,125.0 Lbs.

SECTION IV: MATHEMATICAL CALCULATIONS

P.G. II

INFORMATION USED FOR CALCULATIONS

Overall Packaging Tare Weight (PTW):	1,735.0 Grams	
Overflow Capacity (OFC):		Methanol/Water SG
Methanol/Water	4,092.3 Grams	SG: 0.967
Water	4,232.0 Grams	
Number of Inner Packagings (# IP):	4	
Packing Group	II	
Product Specific Gravity (PSG):	1.950	
Packing Group Multiplication Factor (MF):	1.00	
Overall Height of one Package (OH):	14.25 Inches	
Stack Test-# of Samples Tested Simultaneously:	3	

98% OF OVERFLOW

Overflow Capacity (OFC) x 98%

<u>OFC</u>	x	<u>98%</u>		
4,092.3	x	98% =	4,010.5 Grams	Methanol/Water
4,232.0	x	98% =	4,147.4 Grams	Water

PACKAGE TEST WEIGHTS

Overall Pkg Tare Weight (PTW) + (98% Overflow Capacity (OFC) x # of Inner Pkg (# IP))

<u>PTW</u>	+	<u>(98% OFC)</u>	x	<u># IP)</u>	
1,735	+	4,010.5	x	4	Methanol/Water
1,735	+	4,147.4	x	4	Water
Methanol/Water:		17.7	Kg	39.0	Lbs.
Water:		18.3	Kg	40.3	Lbs.

AUTHORIZED PACKAGE GROSS MASS CALCULATION (APGM)

Overall Pkg Tare Weight (PTW) + (Product SG (PSG) x 98% Overflow (OFC) x # of Inner Pkg (# IP))

<u>PTW</u>	+	<u>(PSG)</u>	x	<u>98% OFC</u>	x	<u># IP)</u>
1,735	+	1.95	x	4,147	x	4
		34.0	Kg	74.9	Lbs.	

DROP HEIGHT					
Calculation For Product Specific Gravities Exceeding 1.2					
Product Specific Gravity (PSG) x Packing Group Multiplication Factor (MF)					
<u>PSG</u>	x	<u>MF</u>		<u>Required Drop Height</u>	<u>Actual Drop Height</u>
1.95	x	1.00		78.7 Inches	79 Inches
		2.00	Meter		
					Packing Group: II

STACKING TEST MINIMUM LOAD CALCULATIONS					
Number of Packages in a 3m High Stack (118 / Overall Pkg Height (OH) -1)					
118 / Overall Height of one Pkg (OH) - 1					
<u>(118)</u>	/	<u>OH)</u>	-1	=	<u># 3m HS</u>
118	/	14.25	-1	=	7.3
Stacking Test Load Calculation (Individual Package)					
Authorized Pkg Gross Mass (APGM) x # of Pkg in a 3m High Stack (# 3m HS)					
<u>APGM</u>	x	<u># 3m HS</u>			
34.0	x	7.3			
		248.2 Kg		547.2 Lbs.	

Stacking Test Load Calculation					
Samples x Authorized Pkg Gross Mass (APGM) x # of Pkg in a 3m High Stack (# 3m HS)					
<u>Samples</u>	x	<u>(APGM</u>	x	<u># 3m HS)</u>	
3	x	34	x	7.3	
		744.6 Kg		1,641.5 Lbs.	